



The electropumps NM, B-NM, NMS, B-NMS series comply with the European Regulation no. 547/2012.

Materials

Components	NM, NMS	B-NM, B-NMS
Pump casing	Cast iron	Bronze
Lantern bracket NM	GJL 200 EN 1561	G-Cu Sn 10 EN 1982
Casing cover for NMS		
Lantern bracket NMS	Cast iron GJL 200 EN 1561	
Impeller	Cast iron GJL 200 EN 1561	Bronze G-Cu Sn 10 EN 1982
	Brass P- Cu Zn 40 Pb 2 UNI 5705 for NM 32/12-16-20, NM 40/20, B-NM 32/125-160-200, B-NM 40/200	
Shaft	AISI 303 up to 2.2 kW	Cr Ni Mo steel AISI 316
	AISI 430 from 3 kW to 75 kW	
Mechanical seal	Carbon - Ceramic - NBR	
Counter-flanges	Steel Fe 430B UNI 7070	

Construction

Close-coupled centrifugal pumps; electric motor with extended shaft directly connected to the pump up to 22 kW, new bracket construction for standard motors (stub-shaft construction) from 30 to 75 kW with integrated thrust bearing.

Pump casing with axial suction and radial delivery on top, main dimensions and performance according to EN 733.

NM(S): version with pump casing and lantern bracket in cast iron.

B-NM(S): version with pump casing and lantern bracket/casing cover in bronze. (the pumps are supplied fully painted).

Connections: Flanges according to PN 10, EN 1092-2.

Counter-flanges (on request)

Sizes	Flanges
from NM 32/.. to NM 50/...	Screwed flanges EN 1092-1, PN 16
from NM 65/.. to NMS 100/...	Flanges for welding EN 1092-1, PN 10

Version with frequency converter (on request)

Applications

For clean liquids without abrasives, which are non-aggressive for the pump materials (solids content up to 0,2%). For water supply.

For heating, air conditioning, cooling and circulation plants.

For civil and industrial applications.

For fire fighting applications. For irrigation.

Operating conditions

Liquid temperature from -10 °C to +90 °C.

Ambient temperature up to 40° C.

Total suction lift up to 7 m.

Maximum permissible working pressure up to 10 bar (16 bar for NM 65/12, NM 65/16 and NM 80/16).

Continuous duty.

Motor

2-pole induction motor, 50 Hz (n ≈ 2900 rpm).

NM, NMS: three-phase 230/400 V ± 10% up to 3 kW; 400/690 V ± 10% from 4 to 75 kW.

Insulation class F. Protection IP 54 (IP 55 for NMS).

Motor suitable for operation with frequency converter from 1,1 kW.

Classification scheme IE3 for three-phase motors from 0,75 kW.

Constructed in accordance with: EN 60034-1; EN 60034-30.

Special features on request

- Other voltages. - Frequency 60 Hz (as per 60 Hz data sheet).
- Protection IP 55.- Special mechanical seal.
- Packed gland (only for NM standard construction).
- Single-phase motor (NMM) up to 1,5 kW.
- Higher or lower liquid or ambient temperatures.
- Motor suitable for operation with frequency converter up to 0,75 kW.

Coverage chart n ≈ 2900 rpm

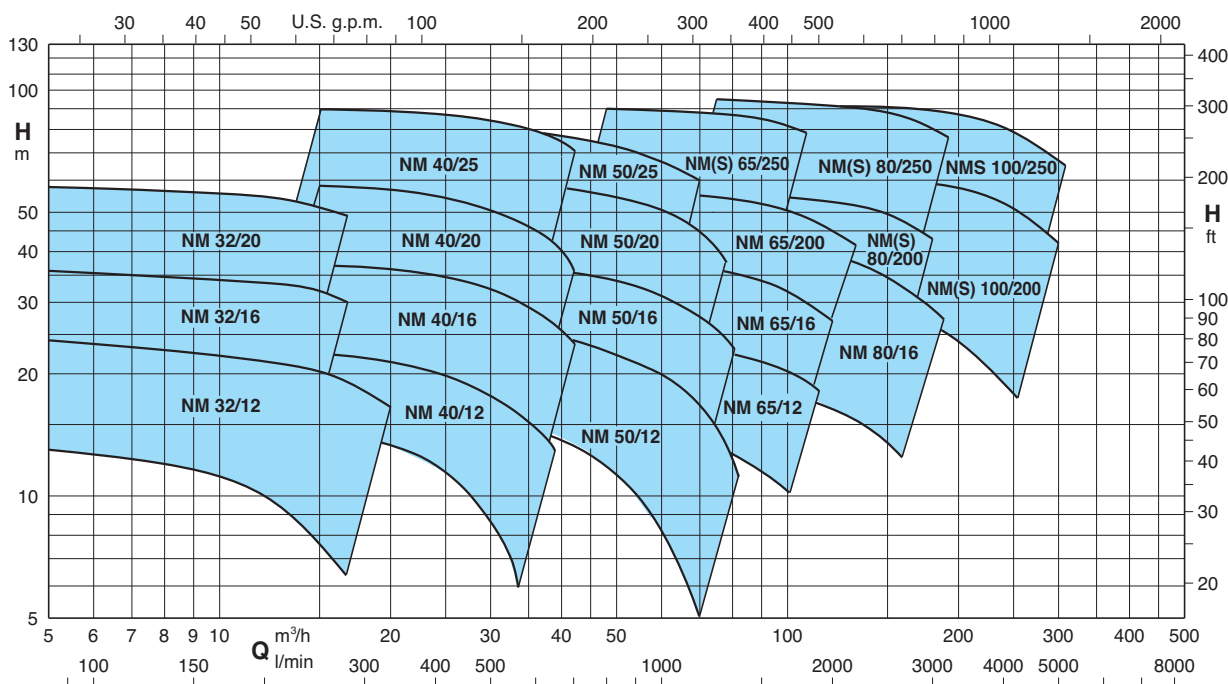

Pumps with frequency converter

The **NM EI** pumps are available with power from 0,55 kW up to 22 kW, the pumps are equipped with **I-MAT** installed on board which allows to realize a variable-speed system extremely compact and efficient, ideal in applications of water supply and in the distribution of hot and cold water.

The pump is equipped with transducers suitable for operation and is already programmed at the factory.

Advantages

- Energy saving
- Compact design
- Easy to use
- Programmable to suit the system requirements
- Reliability

Costruction

The system comprises of:

- Pump
- Induction motor
- I-MAT Frequency converter
- Motor adapter for the motor mounting of the frequency converter
- Connection cable between frequency converter and induction motor
- Transducers

Main features

- Rated motor power output from 0,55 kW to 22 kW
- Control range from 1750 to 2900 rpm (2-pole)
- Protection against dry running
- Protection against operations with closed valve ports
- Protection against system leakages
- Protection against overcurrent in the motor
- Protection against overvoltage and undervoltage of the power supply
- Protection against current unbalances between phases



Operating modes



Constant pressure mode with pressure transducer

In this mode, the system maintains the preset pressure when the flow required by the installation changes.

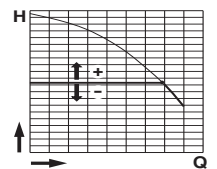

Proportional pressure mode with pressure transducer

In this mode the system changes the working pressure according to the required flow rate.

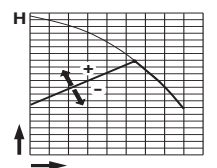

Constant flow mode with flow meter

In this mode the system maintains a constant flow rate value in a point of the installation according to the required pressure.

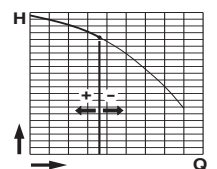

Fixed speed mode with setting of the speed preferential rotation.

In this mode, by changing the working frequency, you may choose any operational curve included within the working range.

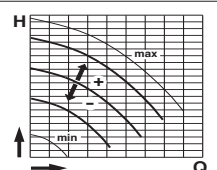

Constant temperature mode with temperature transducer

In this mode the system keeps the temperature constant inside a system by changing the speed of the pump.

Performance n ≈ 2900 rpm

B-NM - B-NMS	NM - NMS	P ₂		Q m ³ /h l/min	H m															
		kW	HP		75	84	96	108	120	132	150	168	180	192	210	240	270	300		
					1250	1400	1600	1800	2000	2200	2500	2800	3000	3200	3500	4000	4500	5000		
B-NM 80/160E/B	NM 80/16E/B	7,5	10	21,5	20,9	19,9	18,7	17,4	15,9	13,4	10,6									
B-NM 80/160D/C	NM 80/16D/C	9,2	12,5	25,2	24,5	23,5	22,4	21,1	19,6	17,2	14,4									
B-NM 80/160C/C	NM 80/16C/C	11	15	28,7	28,2	27,4	26,4	25,1	23,8	21,3	18,5	16,4								
B-NM 80/160B/C	NM 80/16B/C	15	20	34,8	34,5	33,8	33	32,1	30,9	28,9	26,4	24,5	22,4							
B-NM 80/160A/C	NM 80/16A/C	18,5	25	39,9	39,6	39	38,2	37,4	36,4	34,5	32,2	30,3	28,1							
B-NMS 80/200B/A	NM 80/20B	22	30	46,5	46	45,5	44,5	43,5	42	39*	35,5*	32*								
B-NMS 80/200A/A	NMS 80/200A	30	40	56	55,5	55	54	53	52	49,5*	46*	43*								
B-NMS 80/250E/A	NM 80/25E	22	30	51	50	48,5	46,5	44,5	42	38*	33*	29*								
B-NMS 80/250D/A	NMS 80/250D	30	40	65	64	62,5	61	59	56,5	53*	49*	45,5*	41*							
B-NMS 80/250C/A	NMS 80/250C/A	37	50	73,5	73	72	70,5	69	67	63*	59*	55,5*	51,5*							
B-NMS 80/250B/A	NMS 80/250B/A	45	60	84	83,5	82,5	81,5	80	78	74,5*	70,5*	67*	63*							
B-NMS 80/250A/A	NMS 80/250A/A	55	75	95	94,5	93,5	92,5	91,5	90	87,5*	84*	80,5*	76,5*							
B-NMS 100/200E/A	NM 100/200E/B	18,5	25				30	29,5	29	28	27	26	25	23	19*					
B-NMS 100/200D/A	NM 100/20D	22	30				36	35,5	35	34	33	32	31	29	24,5*	19*				
B-NMS 100/200C/A	NMS 100/200C	30	40				45	44,5	44	43,5	42,5	41,5	40,5	39	34,5*	29*	22°			
B-NMS 100/200B/A	NMS 100/200B/A	37	50				54	53,5	53	52,5	51,5	50,5	49,5	48	44*	38,5*	32°			
B-NMS 100/200A/A	NMS 100/200A/A	45	60				61,5	61	60,5	60	59,5	58,5	58	56,5	53*	48*	42°			
B-NMS 100/250B/A	NMS 100/250B/A	55	75				73,5	73	72,5	71,5	70	68,5	67	65	61*	55,5*	48,5°			
B-NMS 100/250A/A	NMS 100/250A/A	75	100				91	90,5	90	89,5	88,5	88	87	85	81*	75*	67°			

NM(S) Standard construction.
B-NM(S) Bronze construction.

P₂ Rated motor power output.
H Total head in m.

* Maximum suction lift 1-2 m.
◦ With 1 m suction head.

Tolerances according to UNI EN ISO 9906:2012

Rated currents

P ₂		230V Δ / 400V Y 400V Δ / 690V Y			I _A /I _N
kW	HP	I _N A	I _N A	I _N A	
0,55	0,75	4	2,3		4,8
0,75	1	4	2,3		4,8
1,1	1,5	4,6	2,7		5,6
1,5	2	7,5	4,3		5,5
2,2	3	9,2	5,3		7,4
3	4	11,5	6,6		8,2
4	5,5		9,6	5,5	7,6
5,5	7,5		10,8	6,2	9,1
7,5	10		14,3	8,3	9,1
9,2	12,5		18,5	10,7	8,2
11	15		21,5	12,4	8,5
15	20		27,3	15,8	9,5
18,5	25		34	19,6	9,4
22	30		41	23,7	10,7
30	40		54	31,2	8,8
37	50		64	36,9	7,2
45	60		77	44,5	7,3
55	75		93	53,7	6,8
75	100		128	73,9	7

P₂ Rated motor power output.
I_A/I_N D.O.L. starting current / Nominal current

Characteristic curves $n \approx 2900$ rpm

2

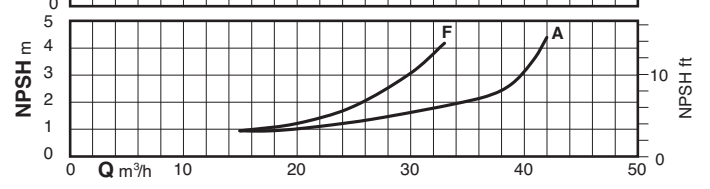
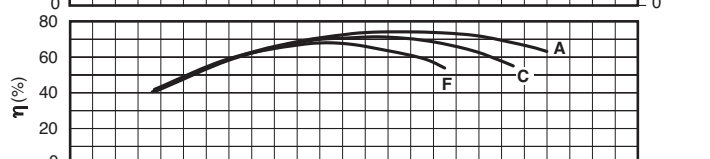
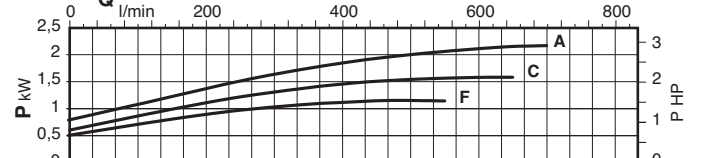
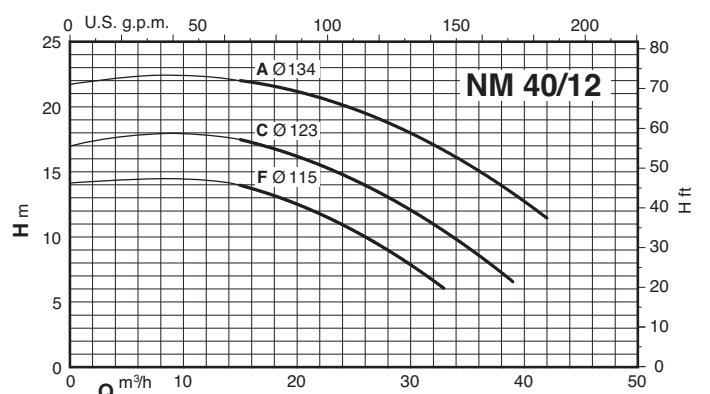
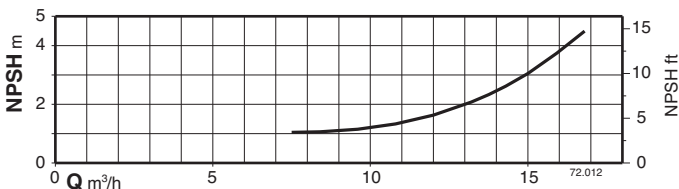
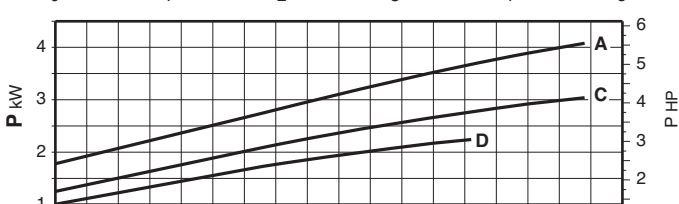
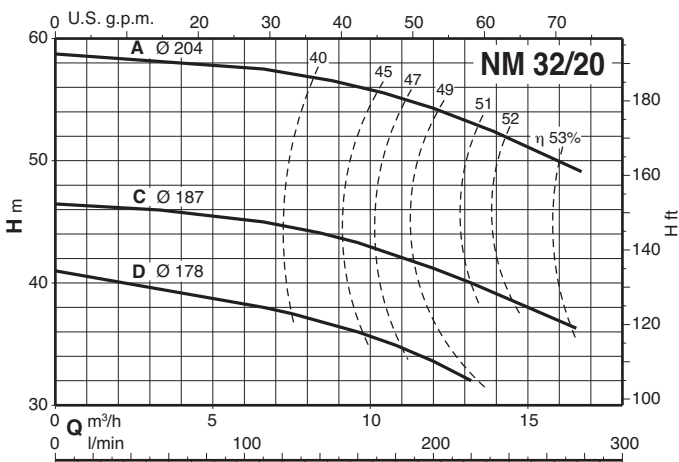
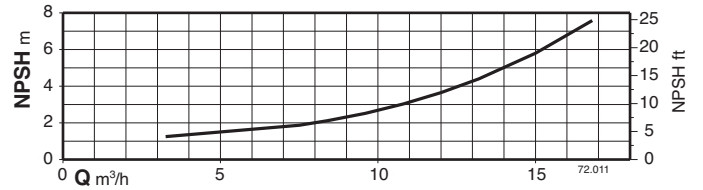
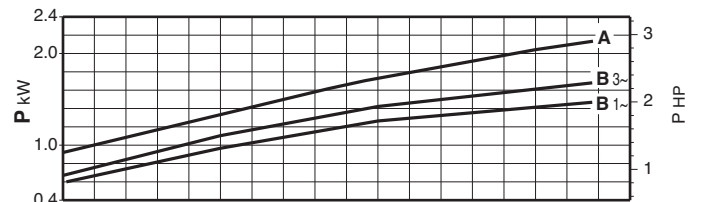
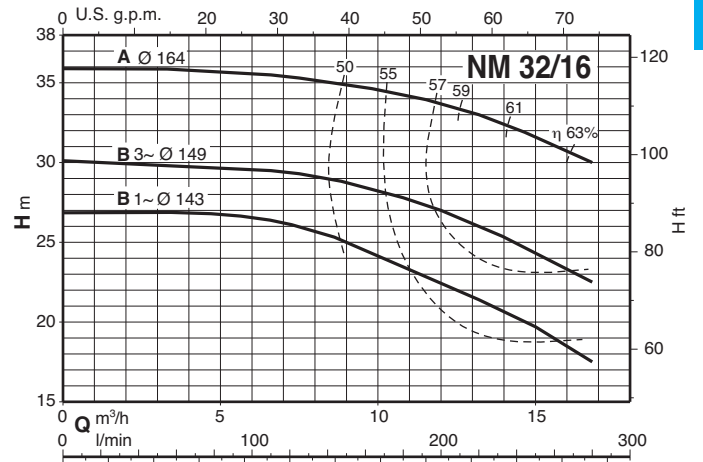
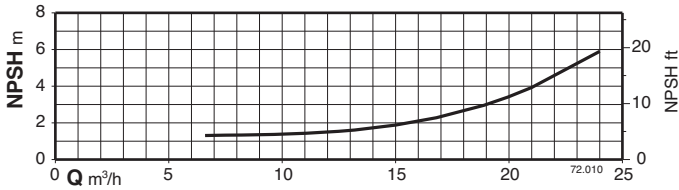
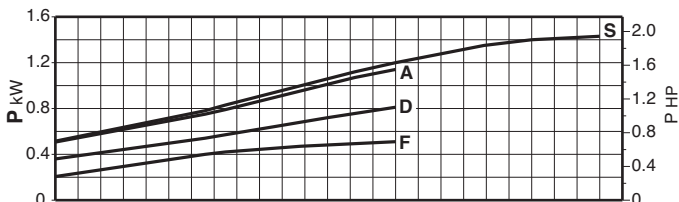
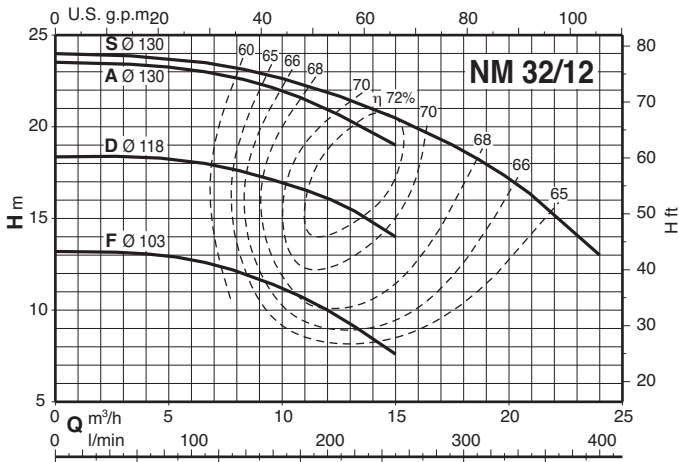

Characteristic curves $n \approx 2900$ rpm

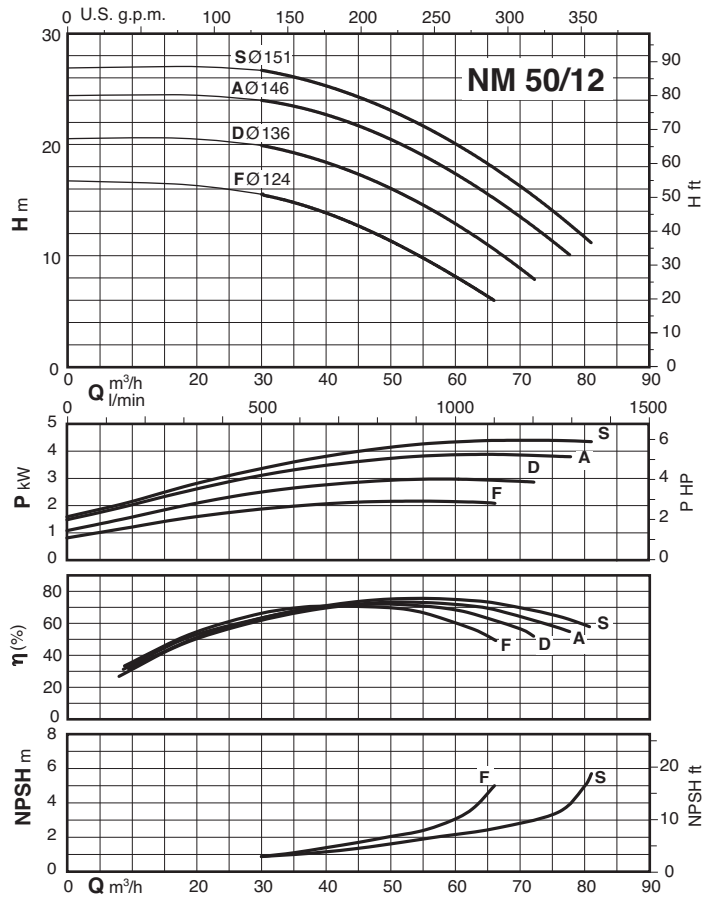
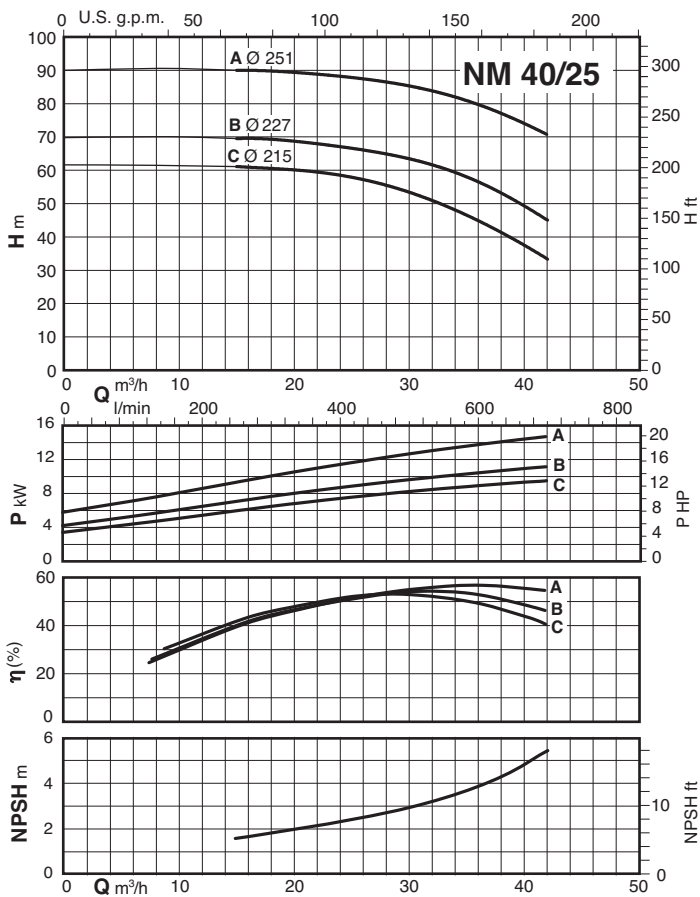
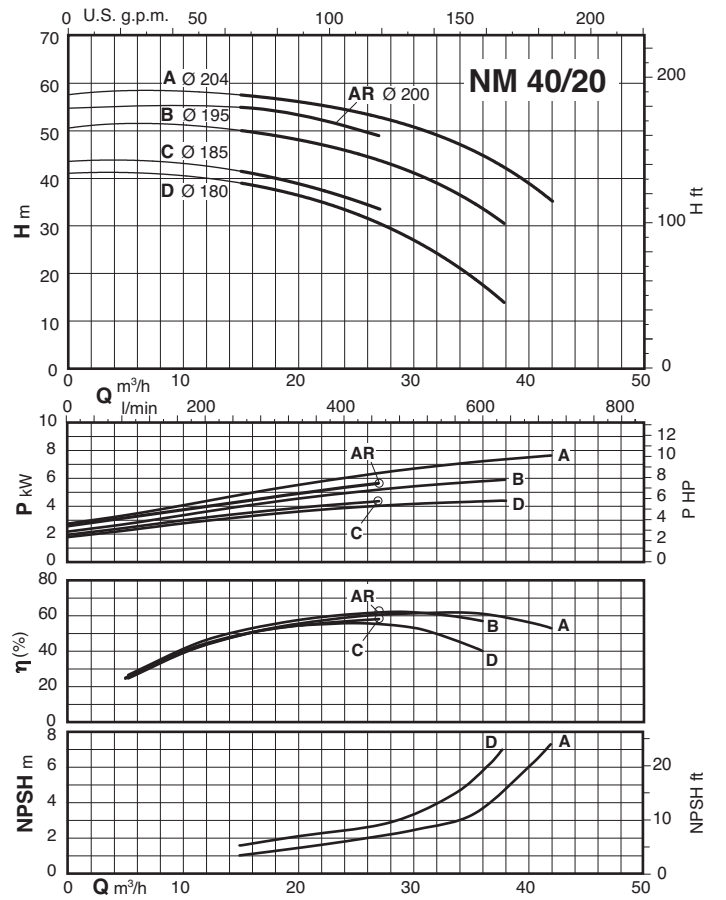
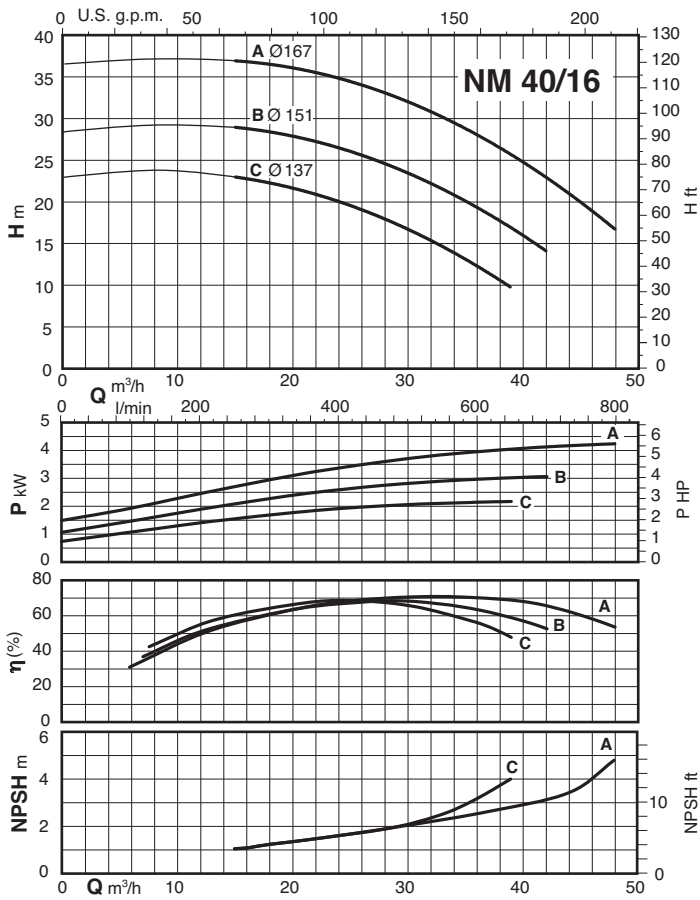

Characteristic curves $n \approx 2900$ rpm

2

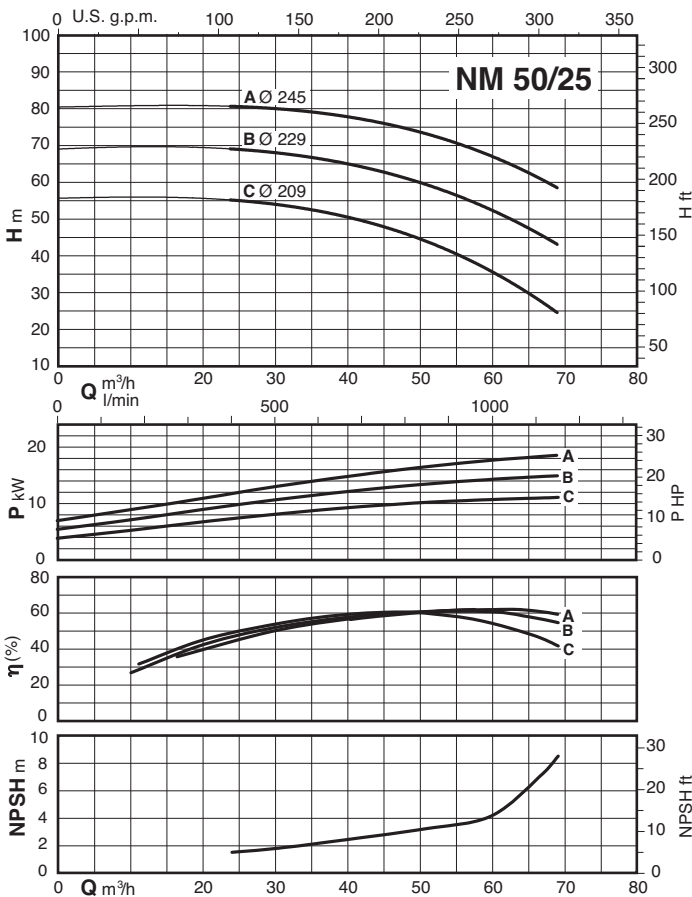
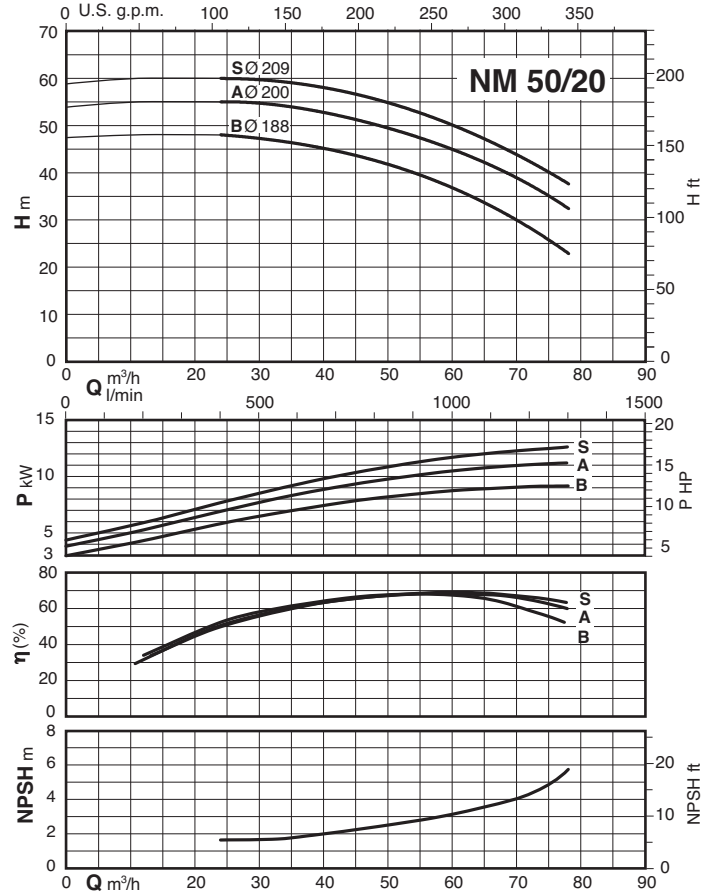
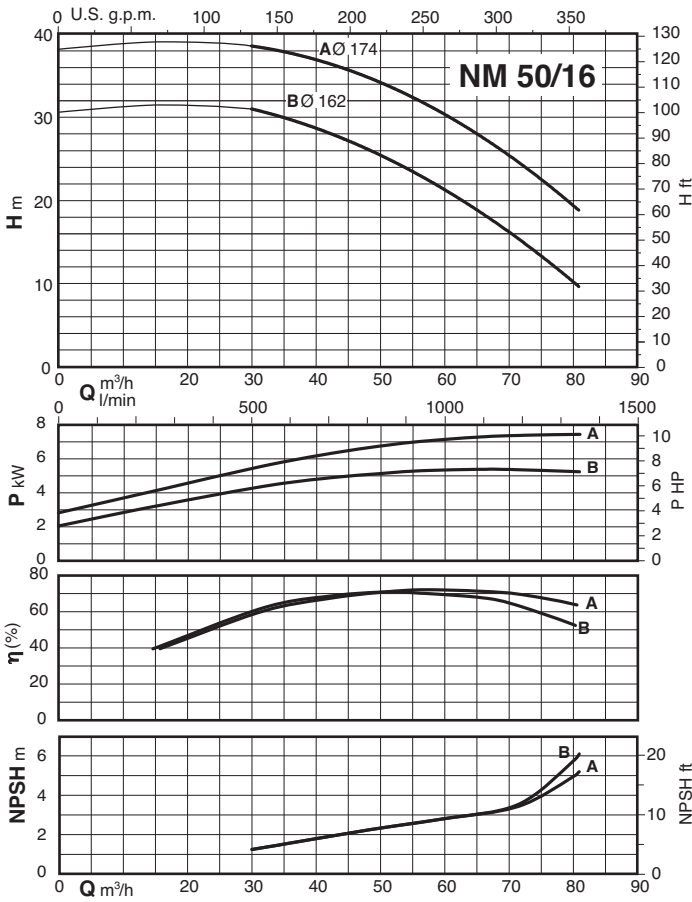

Characteristic curves $n \approx 2900$ rpm

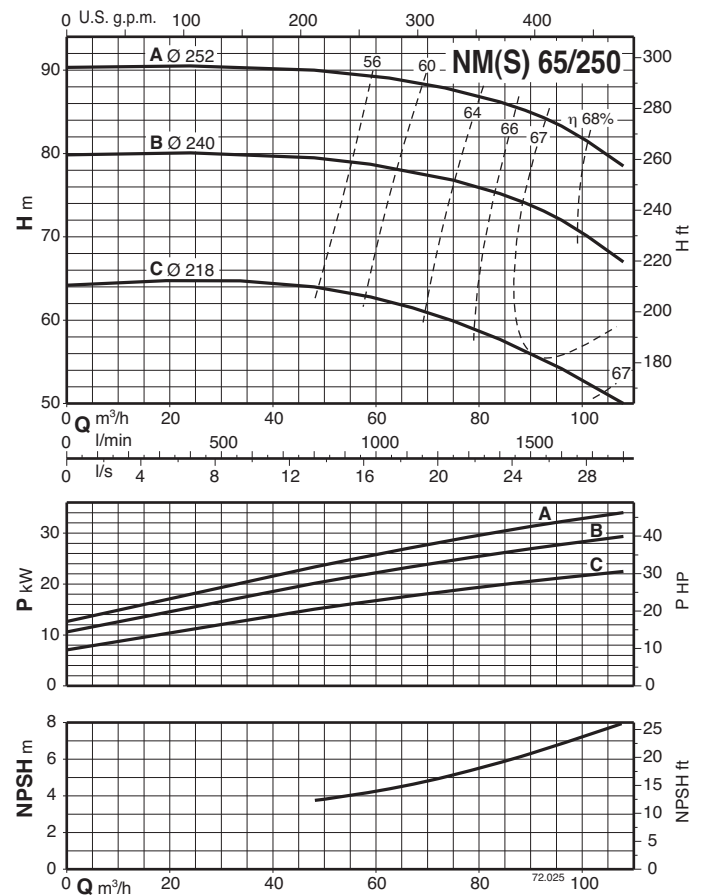
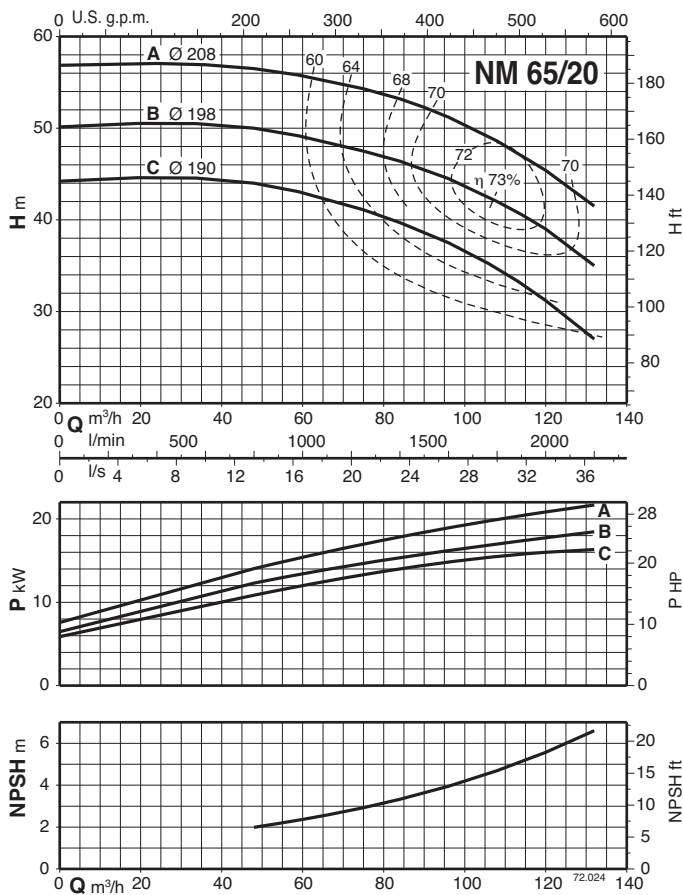
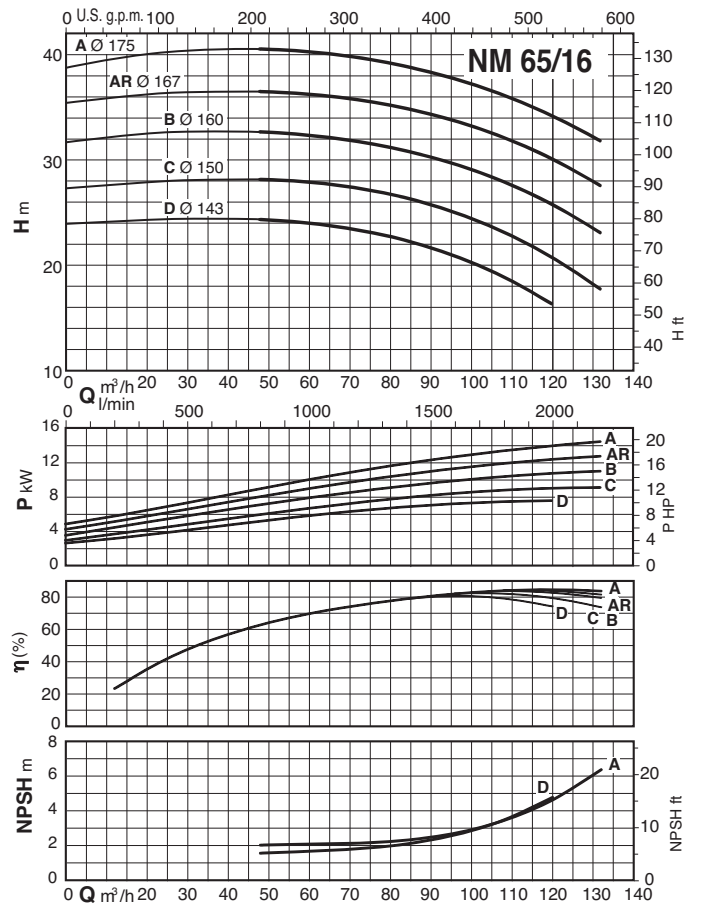
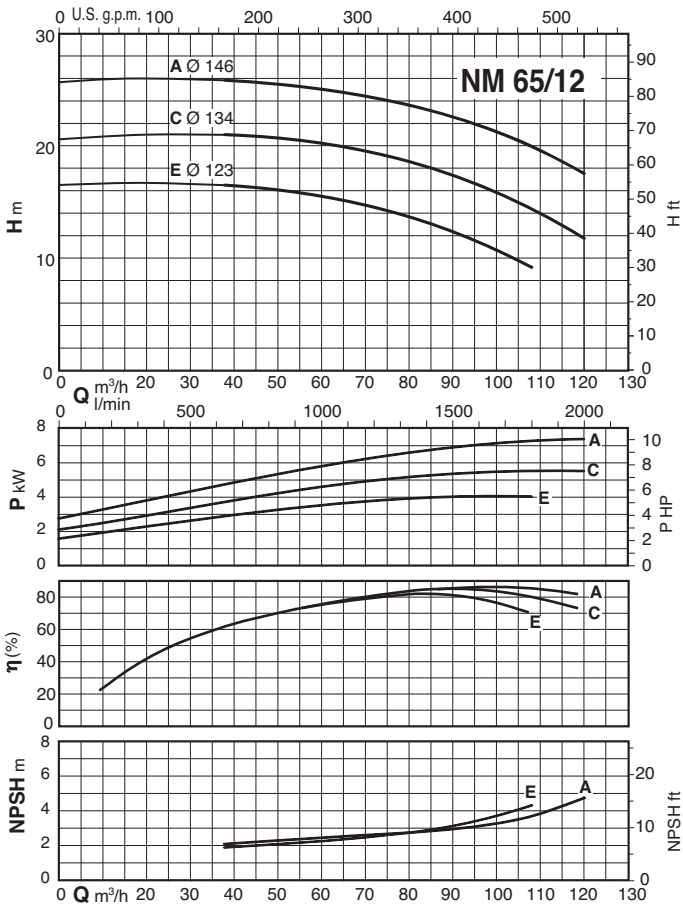

Characteristic curves $n \approx 2900$ rpm

2

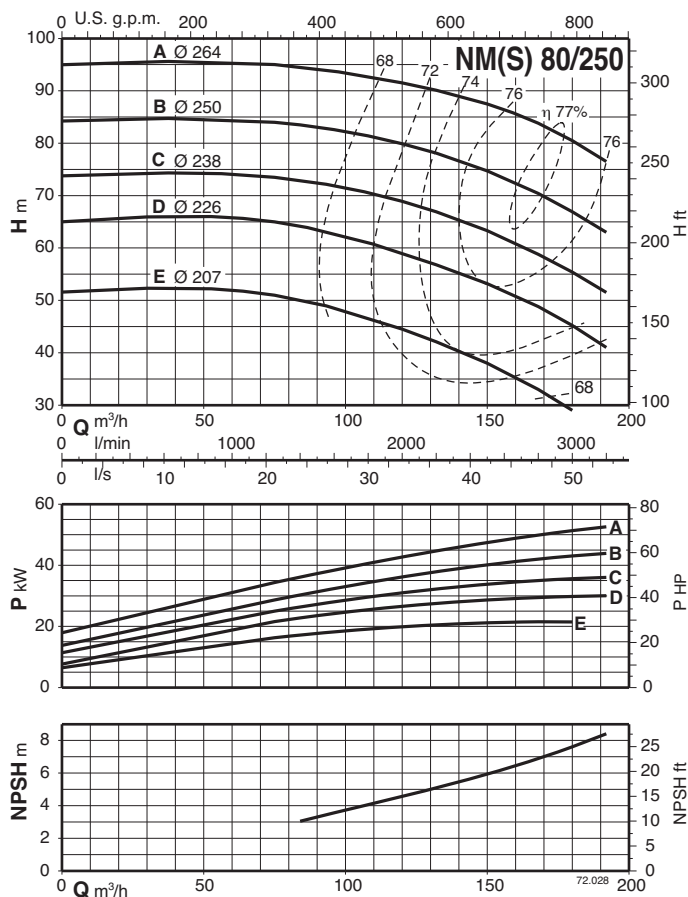
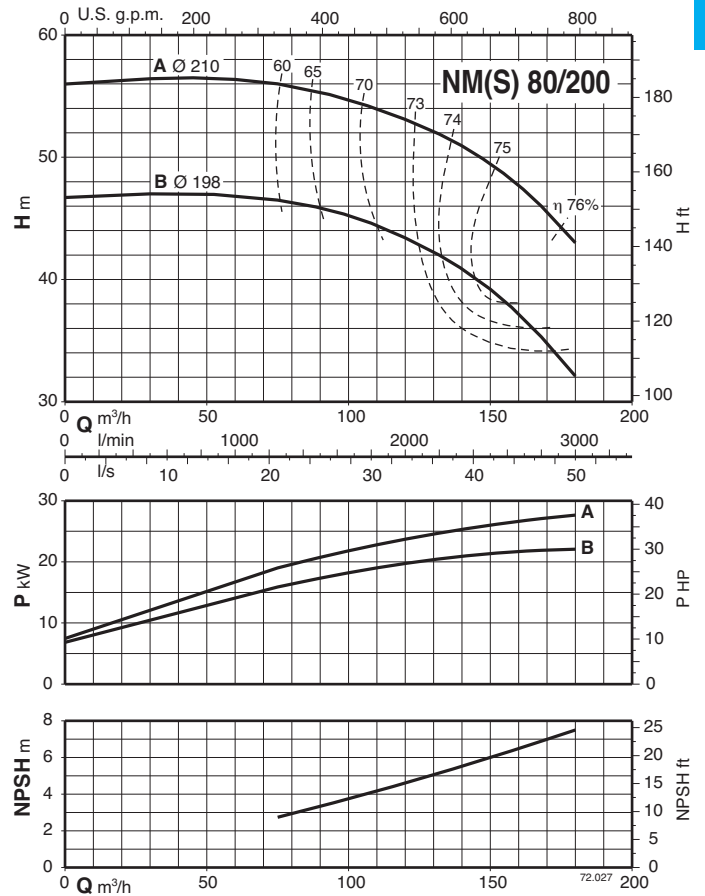
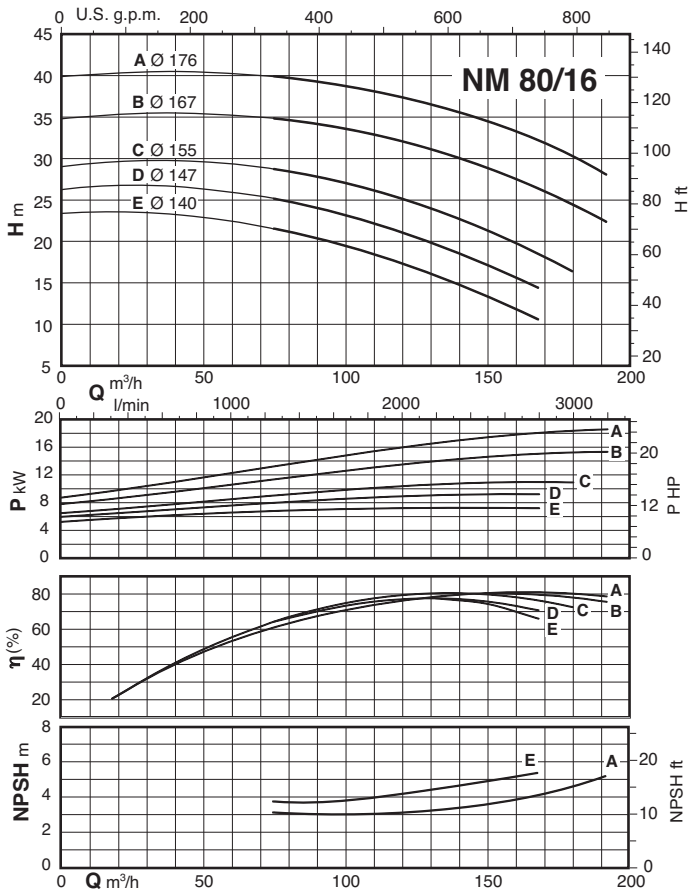

Characteristic curves $n \approx 2900$ rpm

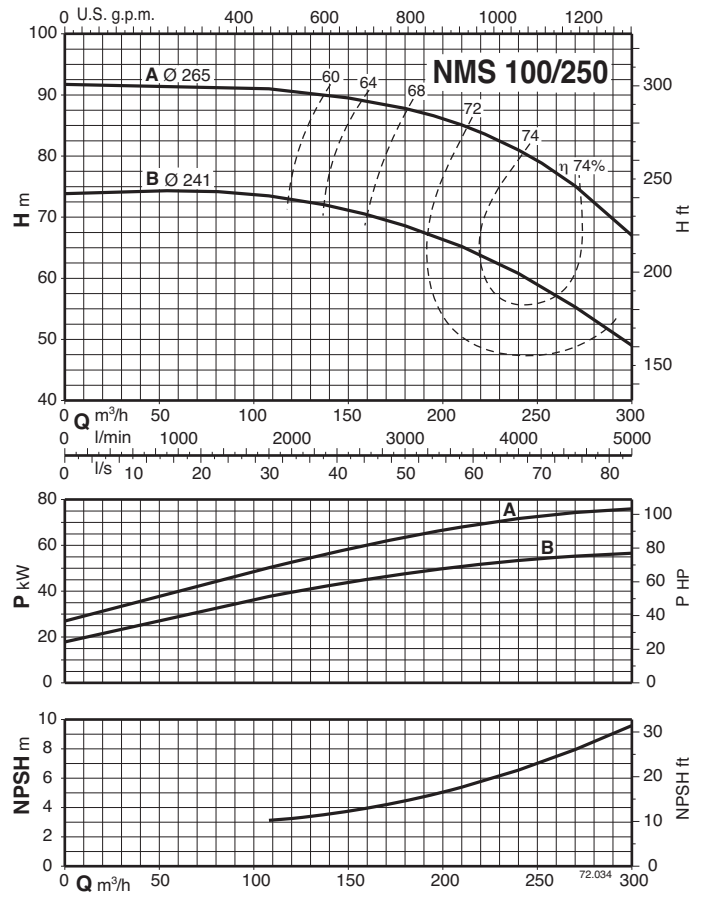
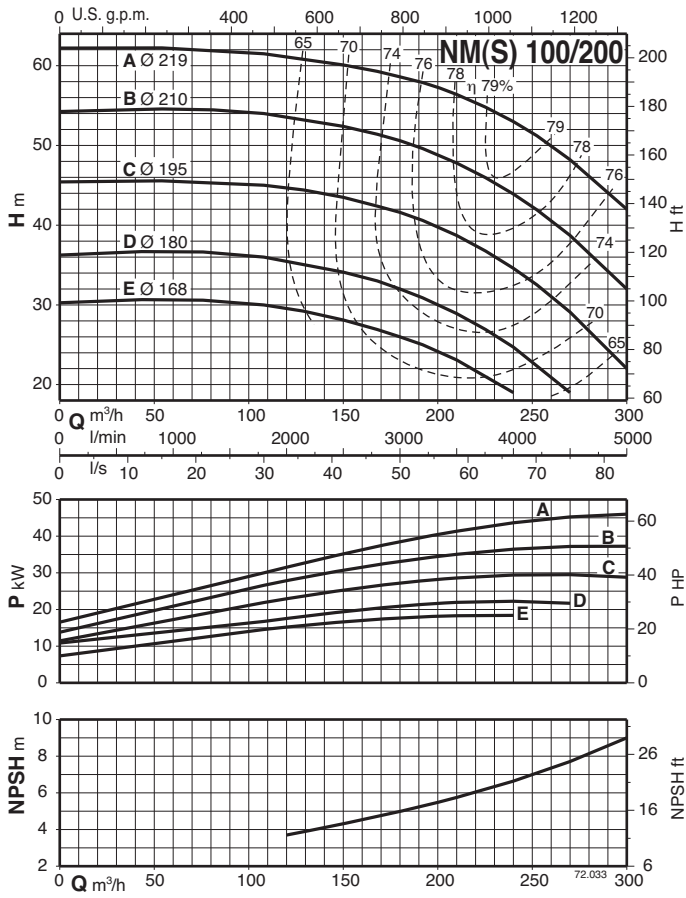

Dimensions and weights

2

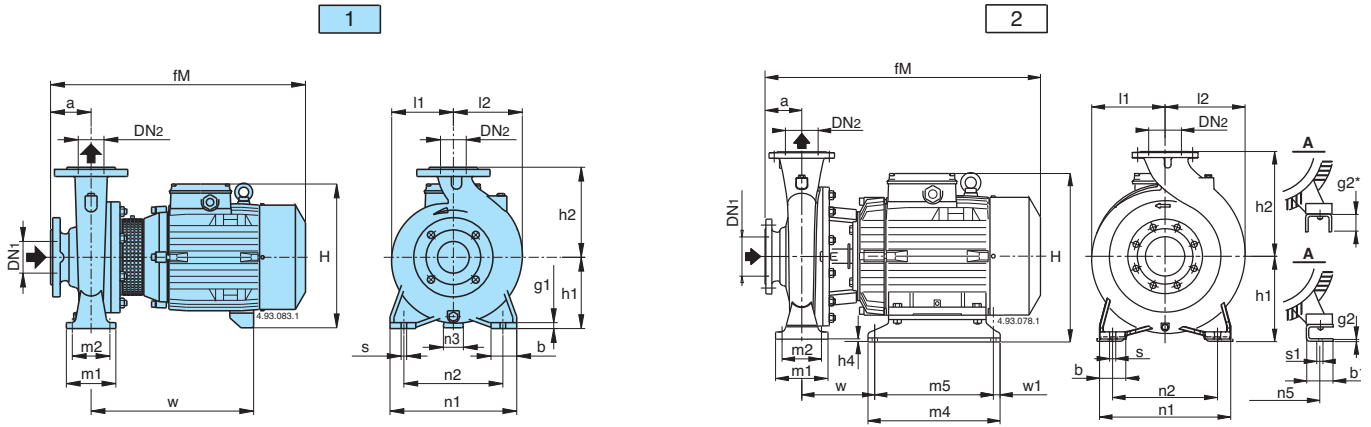

Picture	NM	mm																				kg							
		DN1	DN2	a	fM	h1	h2	H	h4	m1	m2	n1	n2	n3	n5	w1	b	b1	s	s1	l1		l2	w	m4	m5	g1	g2	
1	NM 32/12DE-FE NM 32/12S/A-A/A	50	32	80	405	112	140	240	-	100	70	190	140	37	-	-	50	-	14	-	93	97	245	-	-	12	-	24-24 27-26	
	NM 32/16B/A NM 32/16A/B	50	32	80	410 450	132	160	260	-	100	70	240	190	47	-	-	50	-	14	-	120	120	250 290	-	-	12	-	34 39	
	NM 32/20D/B NM 32/20C/A NM 32/20A/B	50	32	80	450 475 475	160	180	288 298 298	-	100	70	240	190	62 60 60	-	-	50	-	14	-	140	140	290 295 295	-	-	12	-	42 47 51	
	NM 40/12C/B-F/B NM 40/12A/C	65	40	80	410 450	112	140	240	-	100	70	210	160	37	-	-	50	-	14	-	100	113	250 290	-	-	12	-	29-27 32	
	NM 40/16C/C NM 40/16B/B NM 40/16A/C	65	40	80	450 475 475	132	160	260 270 270	-	100	70	240	190	47 45 45	-	-	50	-	14	-	119	119	290 295 295	-	-	12	-	39 46 48	
	NM 40/20C/B-D/B NM 40/20A/A-AR/A-B/A	65	40	100	495 525	160	180	298 320	-	100	70	265	212	60 49	-	-	50	-	14	-	140	140	295 320	-	-	12	-	54-53 73-67-67	
	NM 40/25C/C NM 40/25B/C NM 40/25A/C	65	40	100	640 690 715	180	225	365	-	125	95	320	250	50	-	-	65	-	14	-	175	175	400 460 460	-	-	15	-	108 117 139	
	NM 50/12F/C NM 50/12D/B NM 50/12A/C-S/C	65	50	100	470 495 495	132	160	260 270 270	-	100	70	240	190	47 45 45	-	-	50	-	14	-	121	137	290 295 295	-	-	12	-	40 47 49-49	
	NM 50/16A/B-B/B	65	50	100	525	160	180	320	-	100	70	265	212	49	-	-	50	-	14	-	127	141	320	-	-	14	-	70,5-64	
	NM 50/20B/C NM 50/20A/C NM 50/20S/C	65	50	100	640 690 720	160	200	345	-	100	70	265	212	40	-	-	50	-	14	-	140	153	400 460 460	-	-	15	-	100 109 131	
	NM 50/25C/C NM 50/25B/C NM 50/25A/C	65	50	100	695 720 720	180	225	365	-	125	95	320	250	50	-	-	65	-	14	-	175	175	465 465 465	-	-	15	-	122 145 151	
	NM 65/12E/C NM 65/12A/B-C/B	80	65	100	500 530	160	180	298 320	-	125	95	280	212	60 49	-	-	65	-	14	-	134	156	300 325	-	-	15	-	51,9 70,7-64,7	
	NM 65/16D/B NM 65/16C/C NM 65/16B/C NM 65/16A/C-AR	80	65	100	525 640 690 715	160	200	320 345 345 345	-	125	95	280	212	49 40 40 40	-	-	65	-	14	-	150	172	320 410 410 460	-	-	15	-	70,5 93 112 127	
	NM 65/20C/B NM 65/20B/B	80	65	100	715	180	225	365	-	125	95	320	250	50	-	-	65	-	14	-	155	175	460	-	-	15	-	136 141	
	2	NM 65/20A	80	65	100	762	202	225	408	22	125	95	320	250	-	254	20	80	90	14	14	155	175	182	400	360	-	42*	185
		NM 65/25C	80	65	100	762	202	250	408	2	160	120	360	280	-	254	20	80	90	18	14	175	190	182	400	360	-	42*	201
	1	NM 80/16E/B NM 80/16D/C NM 80/16C/C NM 80/16B/C NM 80/16A/C	100	80	125	545 670 720 745 745	180	225	340 365 365 365 365	-	125	95	320	250	60 50 50 50 50	-	-	65	-	14	-	165	193	320 415 415 465 465	-	-	15	-	77,5 101 120 132 138
		NM 80/20B	100	80	125	787	202	250	408	22	125	95	345	280	-	254	20	80	90	18	14	170	194	182	400	360	-	42*	194
		NM 80/25E	100	80	125	787	202	280	408	2	160	120	400	315	-	254	20	80	90	18	14	191	210	182	400	360	-	42*	203
		NM 100/200E/B° NM 100/20D	125	100	125	800 787	200 202	280	345 408	-	160	120	360	280	-	216 254	20 20	80	69 90	18	12 14	180	212	239 182	298 400	258 360	-	6 42*	179 195

° Version without coupling guard

Pumps with packed gland, dimensions available on request (excluded NMS).

Dimensions and weights

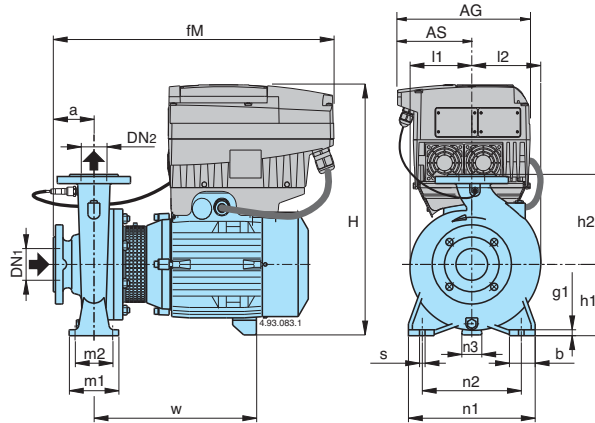

Picture	NM	mm																				kg		
		DN 1	DN 2	a	fM	AG	AS	h1	h2	H	h4	m1	m2	n1	n2	n3	b	s	l1	l2	w		g1	
1	NM EI 32/12DE-FE	50	32	80	435	190	105	112	140	398	-	100	70	190	140	37	50	14	93	97	245	12	30,4-30,4	
	NM EI 32/12S/A-A/A	50	32	80	470	190	105	118	132	160	418	-	100	70	240	190	47	50	14	120	120	250	12	32,4-33,4
	NM EI 32/16B/A	50	32	80	470	190	105	118	132	160	418	-	100	70	240	190	47	50	14	120	120	250	12	40,4
	NM EI 32/16A/B	50	32	80	470	190	105	118	132	160	418	-	100	70	240	190	47	50	14	120	120	250	12	46,5
	NM EI 32/20D/B	50	32	80	485	210	118	160	180	180	446	-	100	70	240	190	62	50	14	140	140	290	12	49,5
	NM EI 32/20C/A	50	32	80	485	210	118	160	180	180	454	-	100	70	240	190	60	50	14	140	140	295	12	54,5
	NM EI 32/20A/B	50	32	80	485	210	118	160	180	180	454	-	100	70	240	190	60	50	14	140	140	295	12	59
	NM EI 40/12C/B-F/B	65	40	80	440	190	105	112	140	140	398	-	100	70	210	160	37	50	14	100	113	250	12	33,4-35,4
	NM EI 40/12A/C	65	40	80	470	210	118	112	140	140	398	-	100	70	210	160	37	50	14	100	113	290	12	39,5
	NM EI 40/16C/C	65	40	80	470	210	118	132	160	160	418	-	100	70	240	190	47	50	14	119	119	290	12	46,5
	NM EI 40/16B/B	65	40	80	485	210	118	132	160	160	426	-	100	70	240	190	45	50	14	119	119	295	12	53,5
	NM EI 40/16A/C	65	40	80	485	210	118	132	160	160	426	-	100	70	240	190	45	50	14	119	119	295	12	56
	NM EI 40/20C/B-D/B	65	40	100	505	210	118	160	180	180	454	-	100	70	265	212	60	50	14	140	140	295	12	61-62
	NM EI 40/20AR/A-B/A	65	40	100	525	281	153	160	180	180	482	-	100	70	265	212	49	50	14	140	140	320	12	75-75
	NM EI 40/20A/A	65	40	100	535	281	153	160	180	180	528	-	100	70	265	212	49	50	14	140	140	320	12	87,8
	NM EI 40/25C/C	65	40	100	640	281	153	180	225	225	573	-	125	95	320	250	50	65	14	175	175	400	15	122,8
	NM EI 40/25B/C	65	40	100	690	281	153	180	225	225	573	-	125	95	320	250	50	65	14	175	175	460	15	131,8
	NM EI 50/12F/C	65	50	100	490	210	118	132	160	160	418	-	100	70	240	190	47	50	14	121	137	290	12	47,5
	NM EI 50/12D/B	65	50	100	505	210	118	132	160	160	426	-	100	70	240	190	45	50	14	121	137	295	12	54,5
	NM EI 50/12A/C-S/C	65	50	100	505	210	118	132	160	160	426	-	100	70	240	190	45	50	14	121	137	295	12	57-57
	NM EI 50/16B/B	65	50	100	525	281	153	160	180	180	482	-	100	70	265	212	49	50	14	127	141	320	14	72
	NM EI 50/16A/B	65	50	100	535	281	153	160	180	180	528	-	100	70	265	212	49	50	14	127	141	320	14	85,3
	NM EI 50/20B/C	65	50	100	640	281	153	160	200	200	553	-	100	70	265	212	40	50	14	140	153	400	15	114,8
	NM EI 50/20A/C	65	50	100	690	281	153	160	200	200	553	-	100	70	265	212	40	50	14	140	153	460	15	123,8
NM EI 50/25C/C	65	50	100	695	281	153	180	225	225	573	-	125	95	320	250	50	65	14	175	175	465	15	136,8	
NM EI 65/12E/C	80	65	100	510	210	118	160	180	180	482	-	125	95	280	212	60	65	14	134	156	300	15	59,9	
NM EI 65/12C/B	80	65	100	530	281	153	160	180	180	528	-	125	95	280	212	49	65	14	134	156	325	15	72,7	
NM EI 65/12A/B	80	65	100	540	281	153	160	180	180	528	-	125	95	280	212	49	65	14	134	156	325	15	85,5	
NM EI 65/16D/B	80	65	100	525	281	153	160	200	200	528	-	125	95	280	212	49	65	14	150	172	320	15	85,3	
NM EI 65/16C/C	80	65	100	640	281	153	160	200	200	553	-	125	95	280	212	40	65	14	150	172	410	15	107,8	
NM EI 65/16B/C	80	65	100	690	281	153	160	200	200	553	-	125	95	280	212	40	65	14	150	172	410	15	126,8	
NM EI 80/16E/B	100	80	125	555	281	153	180	225	225	548	-	125	95	320	250	60	65	14	165	193	320	15	92,3	
NM EI 80/16D/C	100	80	125	670	281	153	180	225	225	573	-	125	95	320	250	50	65	14	165	193	415	15	115,8	
NM EI 80/16C/C	100	80	125	720	281	153	180	225	225	573	-	125	95	320	250	50	65	14	165	193	415	15	134,8	

Dimensions and weights

2

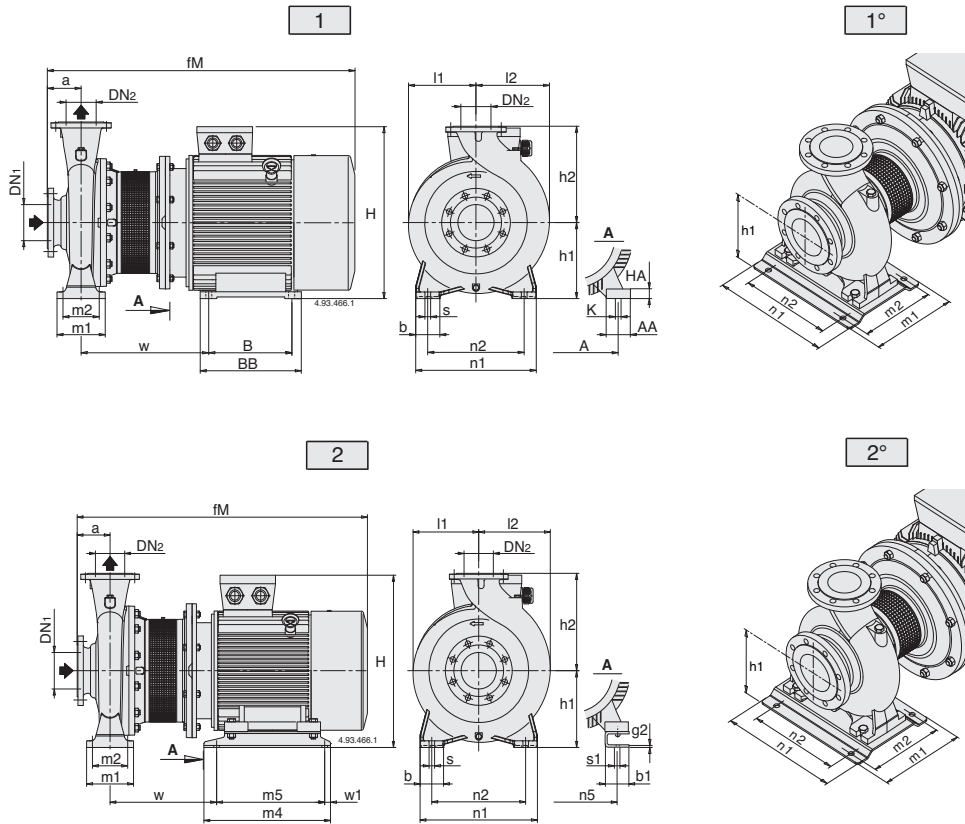

Picture	NMS	mm																										kg			
		DN1	DN2	a	fM	h1	h2	H	m1	m2	n1	n2	A	n5	w1	b	AA	b1	s	K	s1	l1	l2	w	BB	m4	B		m5	HA	g2
2	NMS 65/250B	80	65	100	961	200	250	486	160	120	360	280	-	279	20	80	-	70	18	-	15	177	189	333	-	440	-	400	-	20	269
1	NMS 65/250A/A	80	65	100	1009	200	250	515	160	120	360	280	318	-	-	80	70	-	18	19	-	200	200	406	355	-	305	-	25	-	321
1	NMS 80/200A	100	80	125	986	180	250	466	125	95	345	280	279	-	-	65	65	-	14	19	-	170	194	394	328	-	279	-	20	-	256
2	NMS 80/250D	100	80	125	986	200	280	486	160	120	400	315	-	279	20	80	-	70	18	-	15	191	211	333	-	440	-	400	-	20	276
1	NMS 80/250C/A	100	80	125	1034	200	280	515	160	120	400	315	318	-	-	80	70	-	18	19	-	200	210	406	355	-	305	-	25	-	345
1°	NMS 80/250B/A	100	80	125	1129	225	280	563	298	258	410	315	356	-	-	-	80	-	18	19	-	225	225	445	361	-	311	-	34	-	437
2°	NMS 80/250A/A	100	80	125	1198	280	280	690	260	220	410	315	-	406	25	-	-	100	18	-	24	275	275	443	-	500	-	450	-	8	534
2	NMS 100/200C	125	100	125	986	200	280	486	160	120	360	280	-	279	20	80	-	70	18	-	15	180	212	333	-	440	-	400	-	20	270
1	NMS 100/200B/A	125	100	125	1034	200	280	515	160	120	360	280	318	-	-	80	70	-	18	19	-	200	212	406	355	-	305	-	25	-	338
1°	NMS 100/200A/A	125	100	125	1129	225	280	563	298	258	410	315	356	-	-	-	80	-	18	19	-	225	225	445	361	-	311	-	34	-	426
2°	NMS 100/250B/A	125	100	140	1213	280	280	690	260	220	410	315	-	440	25	-	-	100	18	-	24	275	275	443	-	500	-	450	-	8	545
1°	NMS 100/250A/A	125	100	140	1286	280	280	713	260	220	410	315	457	-	-	-	100	-	18	24	-	275	275	516	479	-	368	-	40	-	648

Flanges EN 1092-2

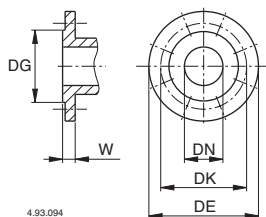

4.93.094

mm						
DN	DG	DK	DE	Holes		W
				N°	Ø	
32	76	100	140	4	19	18
40	84	110	150	4	19	18
50	99	125	165	4	19	20
65	118	145	185	4	19	20
80	132	160	200	8	19	22
100	156	180	220	8	19	24
125	184	210	250	8	19	24

Dimensions and weights

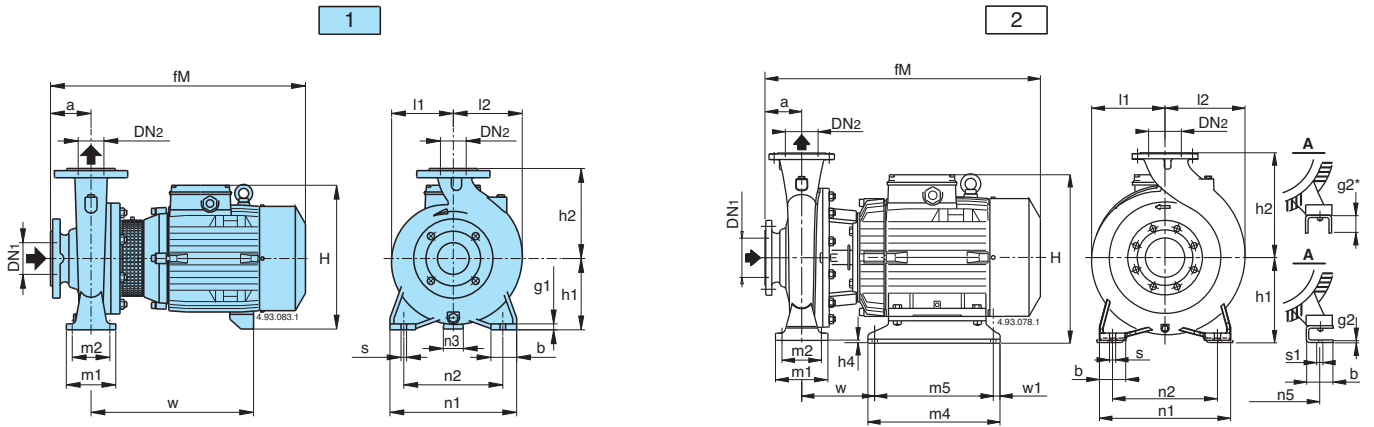

Picture	B- NM	mm																				kg						
		DN1	DN2	a	fM	h1	h2	H	h4	m1	m2	n1	n2	n3	n5	w1	b	b1	s	s1	l1	l2	w	m4	m5	g1	g2	B-NM
1	B-NM 32/12D-F B-NM 32/12S/A-A/A	50	32	80	405	112	140	240	-	100	70	190	140	37	-	-	50	-	14	-	93	97	245	-	-	12	-	27-27 30-28
	B-NM 32/16B/A B-NM 32/16A/B	50	32	80	410 450	132	160	260	-	100	70	240	190	47	-	-	50	-	14	-	120	120	250 290	-	-	12	-	38,5 42
	B-NM 32/20D/B B-NM 32/20C/A B-NM 32/20A/B	50	32	80	450 475 475	160	180	288 298 298	-	100	70	240	190	45 60 60	-	-	50	-	14	-	140	140	290 295 295	-	-	12	-	47,5 56,5 58
	B-NM 40/12C/A-F/A B-NM 40/12A/B	65	40	80	410 450	112	140	240	-	100	70	210	160	37	-	-	50	-	14	-	100	113	250 290	-	-	12	-	33-31 36
	B-NM 40/16C/B B-NM 40/16B/A B-NM 40/16A/B	65	40	80	450 475 475	132	160	260 270 270	-	100	70	240	190	47 45 45	-	-	50	-	14	-	119	119	290 295 295	-	-	12	-	43 50 53
	B-NM 40/20C/B-D/B B-NM 40/200A/A-AR/A-B/A	65	40	100	495 580	160	180	298 320	-	100	70	265	212	60 49	-	-	50	-	14	-	140	140	295 375	-	-	12	-	59,5-59 80,5-75
	2	B-NM 4025/C/C B-NM 4025/B/C B-NM 4025/A/C	65	40	100	635 685 710	192	225	377	12	125	95	320	250	-	216	20	65	69	14	12	175	175	174	298	258	-	6
B-NM 50/12F/B B-NM 50/12D/A B-NM 50/12A/B-S/B		65	50	100	470 495 495	132	160	260 270 270	-	100	70	240	190	47 45 45	-	-	50	-	14	-	121	137	290 295 295	-	-	12	-	44 52 54,5-54
B-NM 50/160A/B-B/B		65	50	100	580	160	180	320	-	100	70	265	212	49	-	-	50	-	14	-	127	141	375	-	-	14	-	80-74,5
2	B-NM 50/200B/C B-NM 50/200A/C B-NM 50/200S/C	65	50	100	695 745 769	192	200	377	32	100	70	265	212	-	216	20	50	69	14	12	140	153	234	298	258	-	6	123 132 154
	B-NM 5025/C/C B-NM 5025/B/C B-NM 5025/A/C	65	50	100	685 710 710	192	225	377	12	125	95	320	250	-	216	20	65	69	14	12	175	175	174	298	258	-	6	135 156 161
	B-NM 65/12E/A	80	65	100	500	160	180	298	-	125	95	280	212	60	-	-	65	-	14	-	134	156	300	-	-	15	-	57,3
1*	B-NM 65/125A/B-C/B	80	65	100	585	160	180	320	-	125	95	280	212	49	-	-	65	-	14	-	134	156	380	-	-	15	-	80,5-74,5
	B-NM 65/160D/B B-NM 65/160C/C	80	65	100	575 660	160	200	320 345	-	125	95	280	212	49 40	-	-	65	-	14	-	150	172	375 430	-	-	15	-	83,5-79 106
2	B-NM 65/160B/C B-NM 65/160A/C-AR	80	65	100	745 770	192	200	377	32	125	95	280	212	-	216	20	65	69	14	12	150	172	234	298	258	-	6	133 156
	B-NM 65/200B/B-C/B B-NM 65/200A/A	80	65	100	775 825	192	225	377 408	12	125	95	320	250	-	216 254	20	65	69 90	14	12 14	155	175	239 245	298 400	258 360	-	6	183-169,5 200
	B-NM 65/250C/B	80	65	100	825	202	250	408	2	160	120	360	280	-	254	20	80	90	18	14	175	190	245	400	360	-	42*	210
1*	B-NM 80/160E/B B-NM 80/160D/C	100	80	125	605 685	180	225	340 365	-	125	95	320	250	60 50	-	-	65	-	14	-	165	193	375 430	-	-	15	-	94 114
	B-NM 80/160C/C B-NM 80/160B/C B-NM 80/160A/C	100	80	125	775 800 800	192	225	377	12	125	95	340	250	-	216	20	65	69	14	12	165	193	239	298	258	-	6	140 166 172

* Version without coupling guard

Dimensions and weights

2

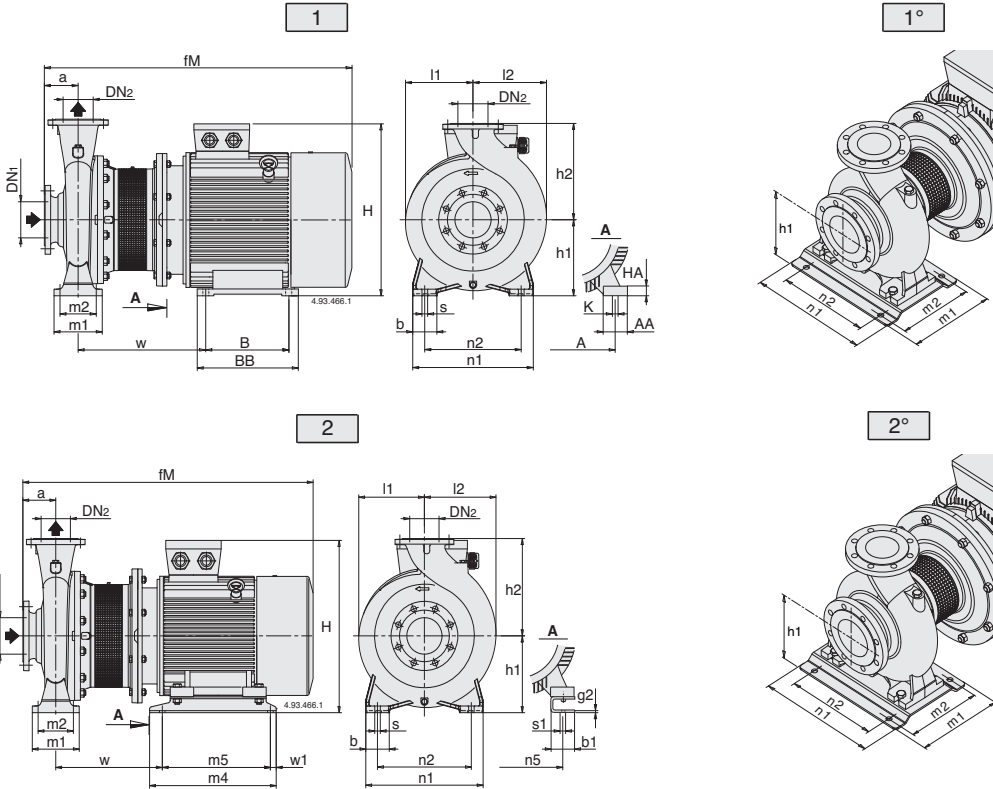

Picture	B-NMS	mm																							kg						
		DN1	DN2	a	fM	h1	h2	H	m1	m2	n1	n2	A	n5	w1	b	AA	b1	s	K	s1	l1	l2	w		BB	m4	B	m5	HA	g2
2	B-NMS 65/250B/A	80	65	100	961	200	250	486	160	120	360	280	-	279	20	80	-	70	18	-	15	177	189	333	-	440	-	400	-	20	-
1	B-NMS 65/250A/A	80	65	100	1009	200	250	515	160	120	360	280	318	-	80	70	-	18	19	-	200	200	406	355	-	305	-	25	-	353	-
2	B-NMS 80/200B/A	100	80	125	936	180	250	387	125	95	345	280	-	254	20	65	-	60	14	-	15	175	194	331	-	350	-	310	-	5	-
1	B-NMS 80/200A/A	100	80	125	986	180	250	466	125	95	345	280	279	-	65	65	-	14	15	-	170	194	394	328	-	279	-	20	-	266	-
2	B-NMS 80/250E/A	100	80	125	936	200	280	407	160	120	400	315	-	254	20	80	-	60	18	-	15	191	210	331	-	394	-	354	-	6	-
2	B-NMS 80/250D/A	100	80	125	986	200	280	486	160	120	400	315	-	279	20	80	-	70	18	-	15	191	212	333	-	440	-	400	-	20	287
1	B-NMS 80/250C/A	100	80	125	1034	200	280	515	160	120	400	315	318	-	80	70	-	18	19	-	200	210	406	355	-	305	-	25	-	-	-
1°	B-NMS 80/250B/A	100	80	125	1129	225	280	563	298	258	410	315	356	-	-	80	-	18	19	-	225	225	445	361	-	311	-	34	-	-	-
2°	B-NMS 80/250A/A	100	80	125	1198	280	280	690	260	220	410	315	-	406	25	-	-	100	18	-	24	275	275	443	-	500	-	450	-	8	-
2	B-NMS 100/200E/A	125	100	125	882	200	280	387	160	120	360	280	-	216	20	80	-	69	18	-	12	180	212	322	-	298	-	258	-	6	250
2	B-NMS 100/200D/A	125	100	125	936	200	280	407	160	120	360	280	-	254	20	80	-	60	18	-	15	180	212	331	-	394	-	354	-	6	-
2	B-NMS 100/200C/A	125	100	128	1034	200	280	535	160	120	360	280	-	279	20	80	-	70	18	-	15	180	212	345	-	440	-	400	-	20	-
1	B-NMS 100/200B/A	125	100	125	1034	200	280	515	160	120	360	280	318	-	80	70	-	18	19	-	200	212	406	355	-	305	-	25	-	352	-
1°	B-NMS 100/200A/A	125	100	125	1129	225	280	563	298	258	410	315	356	-	-	80	-	18	19	-	225	225	445	361	-	311	-	34	-	-	-
2°	B-NMS 100/250B/A	125	100	140	1213	280	280	690	260	220	410	315	-	440	25	-	-	100	18	-	24	275	275	443	-	500	-	450	-	8	-
1°	B-NMS 100/250A/A	125	100	140	1286	280	280	713	260	220	410	315	457	-	-	-	-	100	-	18	24	-	275	275	516	479	-	368	-	40	-

Flanges EN 1092-2

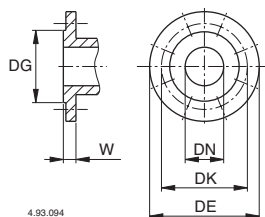

4.93.094

mm						
DN	DG	DK	DE	Holes		W
				N°	Ø	
32	76	100	140	4	19	18
40	84	110	150	4	19	18
50	99	125	165	4	19	20
65	118	145	185	4	19	20
80	132	160	200	8	19	22
100	156	180	220	8	19	24
125	184	210	250	8	19	24

Features

Cutting edge hydraulics

The geometry of the impeller and the pump casing are optimized to achieve maximum efficiency and the best suction capability.

Flexible

The option to choose between cast iron and bronze materials for the hydraulic parts in contact with the pumped liquid allows NM series pumps to be selected for use with different types of liquids.

Compact Design

The compact design allows for easy installation even in confined spaces.

Exclusive design

An innovative, patented guard prevents contact with rotating parts, proving protection to the end user whilst allowing for inspection of the mechanical seal.

Reliable

The bearing and shaft are designed to ensure the reduction of the stress, providing high reliability under all operating conditions.

NM

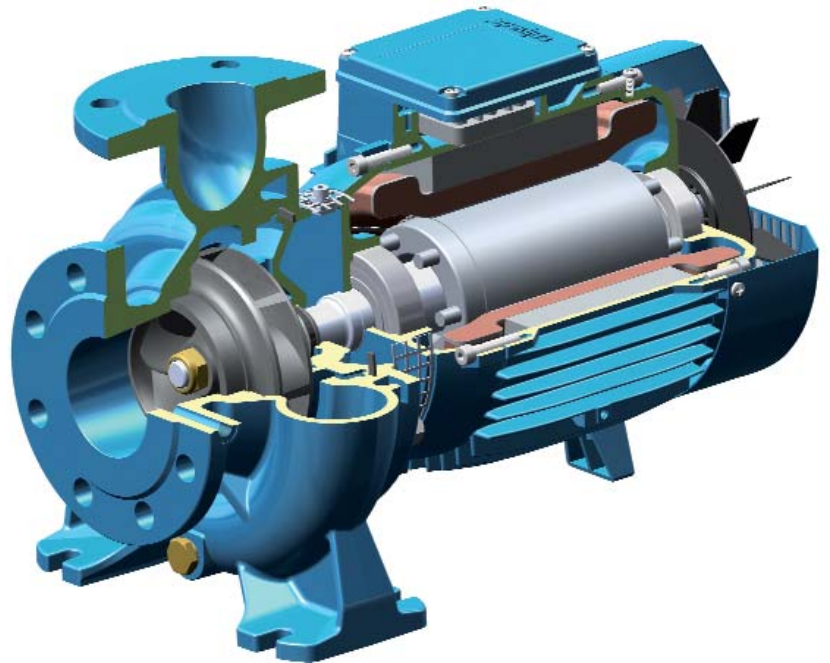

Cutting edge hydraulics

The geometry of the impeller and the pump casing are optimized to achieve maximum efficiency and the best suction capability.

Flexible

The option to choose between cast iron and bronze materials for the hydraulic parts in contact with the pumped liquid allows NMS series pumps to be selected for use with different types of liquids.

New lantern bracket construction

The lantern brackets incorporate a thrust bearing on the hydraulic side which guarantees the elimination of additional loads on the motor bearings. The flange is sized to be used with standard motors B35.

Exclusive design

An innovative, patented guard prevents contact with rotating parts, proving protection to the end user whilst allowing for inspection of the mechanical seal.

Simplified motor maintenance

The presence of the thrust bearing on the hydraulic side makes it easier to remove the motor, facilitating maintenance operations and eliminating the risks of damage to the hydraulic parts.

NMS

